



### KEY FEATURES

- High-Density Fiberboard Surface
- 14 Gauge Recycled Steel Frame
- High-Pressure WilsonArt Laminate
- Scratch / Dirt Resistant Powder Coat
- Premium T-Molding
- American Made
- Lifetime Warranty

### CERTIFICATIONS

- ANSI/BIFMA Certified
- LEED Credit Potential
- Sustainable Furnishings Council

MODEL #	WIDTH	DEPTH	HEIGHT	WEIGHT
DVT-3624	36"	24"	27" to 38"	97 lbs.
DVT-3630	36"	30"	27" to 38"	102 lbs.
DVT-4824	48"	24"	27" to 38"	114 lbs.
DVT-4830	72"	30"	27" to 38"	119 lbs.
DVT-6024	60"	24"	27" to 38"	134 lbs.
DVT-6030	60"	30"	27" to 38"	139 lbs.
DVT-7224	72"	24"	27" to 38"	154 lbs.
DVT-7230	72"	30"	27" to 38"	157 lbs.

### INCLUDED ACCESORIES

- (1) Enclosed CPU Holder per User
- (1) Keyboard Tray per User

### SURFACE COLORS

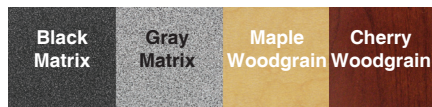

### FRAME COLORS

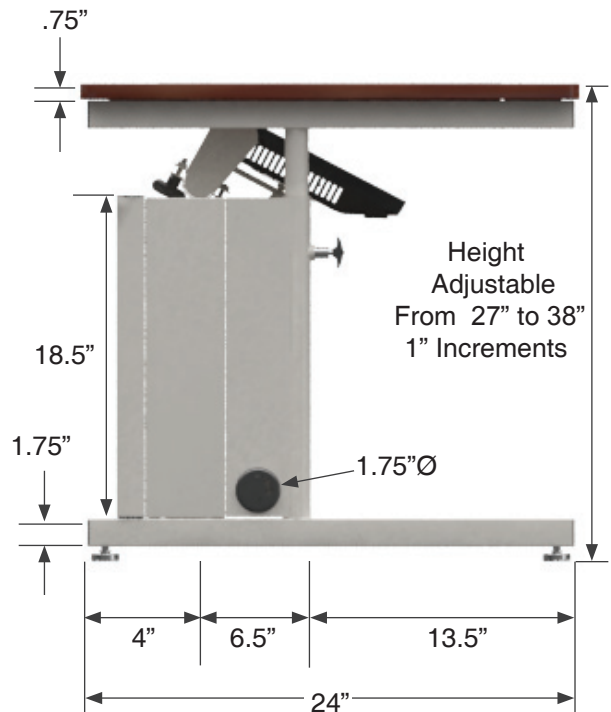
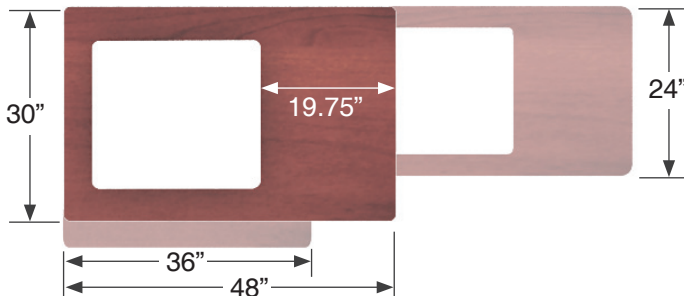
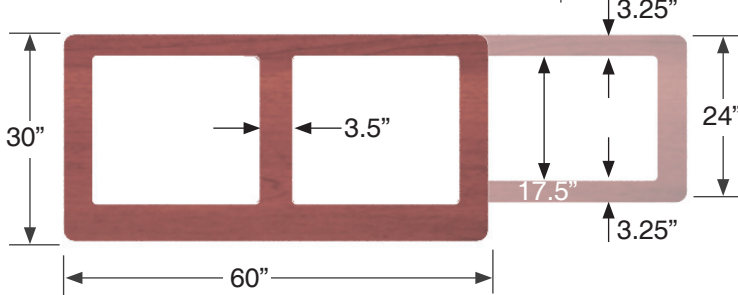
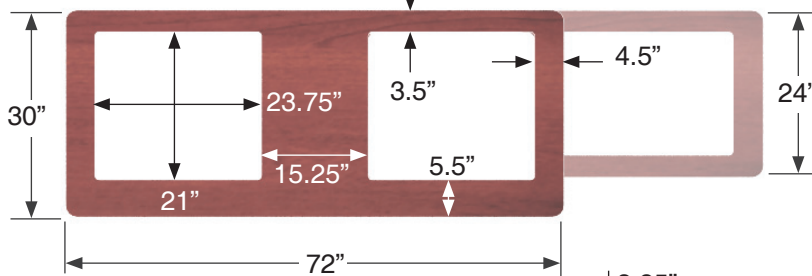
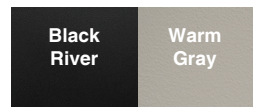

Underside View

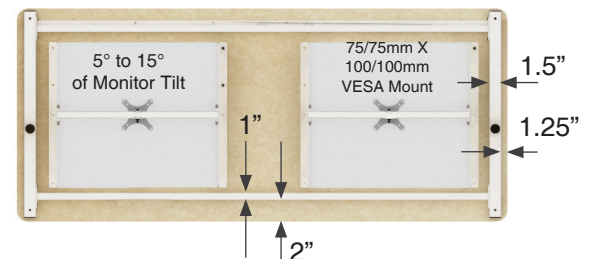

Revised: 05-02-14



VersaTables.com  
14105 Avalon Blvd.  
Los Angeles, CA 90061



Proudly Made in the USA

### Sales:

Call: 800-416-3961  
Call: 310-353-7100  
Fax: 310-353-7109

### Customer Service:

Call: 424-244-2155  
service@versaproducts.com