



















Revolution Table Series
RST 36", 48", 60" & 72"

Assembly Instructions



How can we improve our assembly instructions?
Your comments and suggestions are important to us.
Please e-mail us at: support@versatables.com.

<p>50mm Furniture Bolt</p>  <p>Qty:4</p>	<p>20mm Furniture Bolt</p>  <p>Qty:20</p>	<p>4mm Allen Wrench</p>  <p>Qty:1</p>	<p>1/2-13 Leveler</p>  <p>Qty:4</p>	<p>Caster & Caster with Lock</p>  <p>OPTIONAL Qty:2</p>
<p>8mm LCD Flat Screen Mounting Screw</p>  <p>Qty:4 for 36" & 48" Qty:8 for 60" & 72"</p>	<p>Main Platform with Built in Cross Support</p>  <p>Qty:1</p>		<p>Zip Tie & Curl Tie</p>  <p>Qty:5</p>	
<p>18mm LCD Flat Screen Mounting Screw</p>  <p>Qty:4 for 36" & 48" Qty:8 for 60" & 72"</p>	 <p>Qty:1</p>		<p>Kick Panel</p>  <p>Qty:1</p>	
<p>3/16" Spacer</p>  <p>Qty:4 for 36" & 48" Qty:8 for 60" & 72"</p>	<p>Cross Support</p>  <p>Qty:1</p>		<p>Keyboard Drawer</p>  <p>Qty:1 for 36" & 48" Qty:2 for 60" & 72"</p>	<p>Side Frame L & R</p>  <p>Qty:2</p>
<p>3/4" Phillips Pa Head Screw</p>  <p>Qty:4 for 36" & 48" Qty:8 for 60" & 72"</p>	<p>Cable Management Tray</p>  <p>Qty:1</p>		<p>CPU Holder</p>  <p>Qty:0 for 36" & 60" Qty:1 for 48" Qty:2 for 72"</p>	<p>Kick Panel Extension L & R</p>  <p>Qty:2</p>
<p>Cable Management Clip</p>  <p>Qty:3 for 36" & 48" Qty:6 for 60" & 72"</p>				

Step 1

Insert Levelers

Insert Levelers into Side Frames L & R.

Leveling Glide



Qty:4



Step 2

Kick Panel Extensions

Attach Left and Right Kick Panel Extensions using (2) 20mm Furniture Bolts on each.

20mm Furniture Bolt



Qty:4

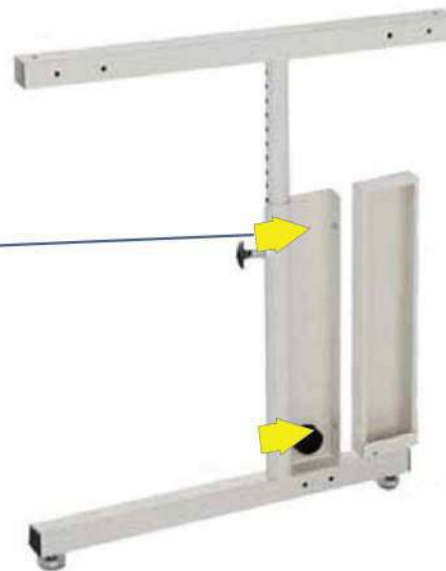
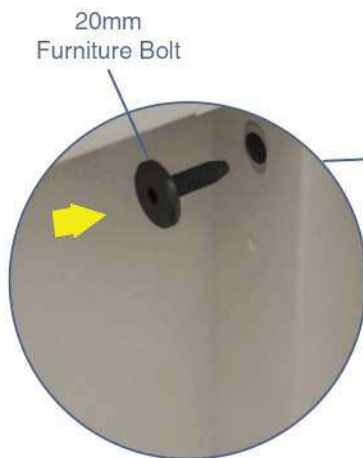

Step 3

Attach Cable Management Tray

Attach Cable Management Tray to Kick Panel Extensions using (2) 20mm Furniture Bolts on each side. Insert Bolts half way through the Kick Panel Extensions then drop the Cable Management Tray.

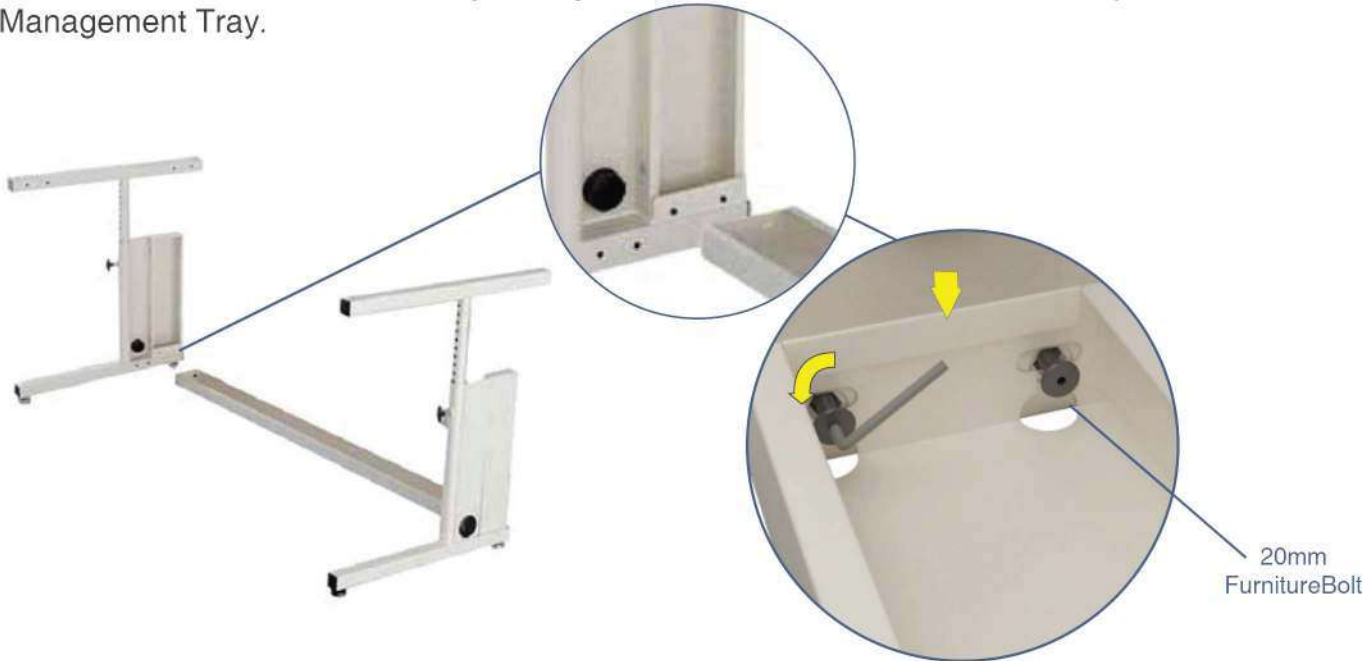

Step 4

Attach Kick Panel

Attach Kick Panel down to Side Frames using (4) 20mm Furniture Bolts.

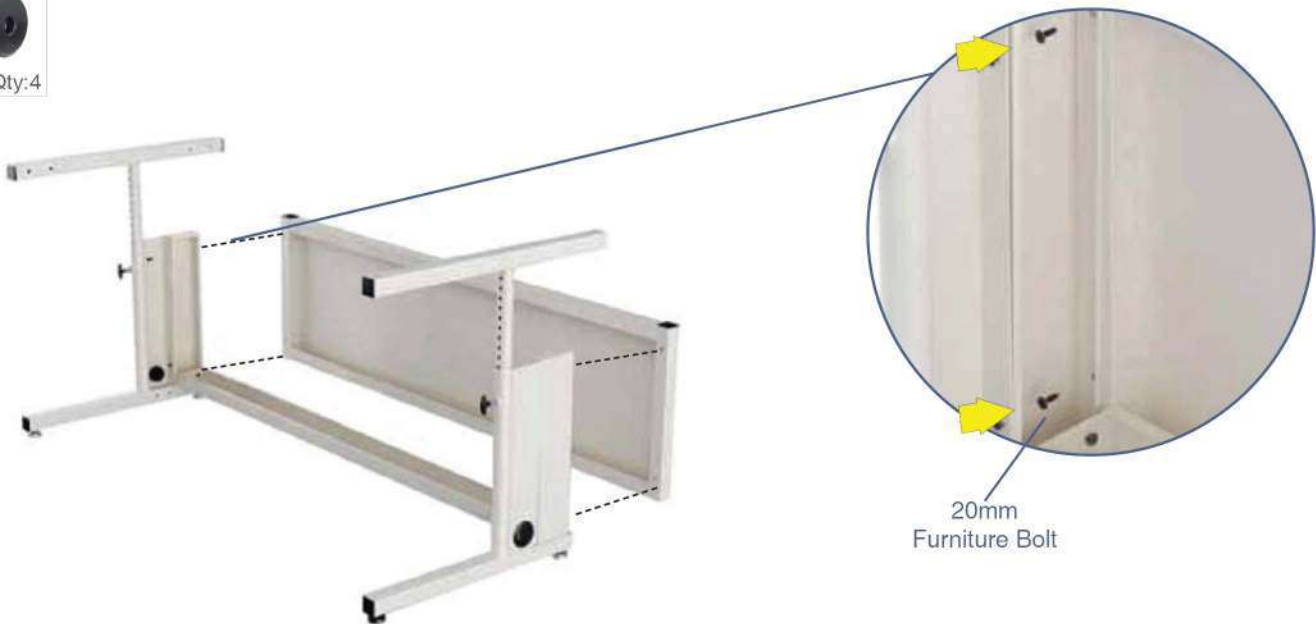

Step 5

LCD Monitor Holder

Remove the Monitor Holders from the surface. Then attach Monitor Holders using (4) 8mm Phillips Machine Screws on each LCD monitor Holder.

8mm Phillips Machine Screw



Qty:8

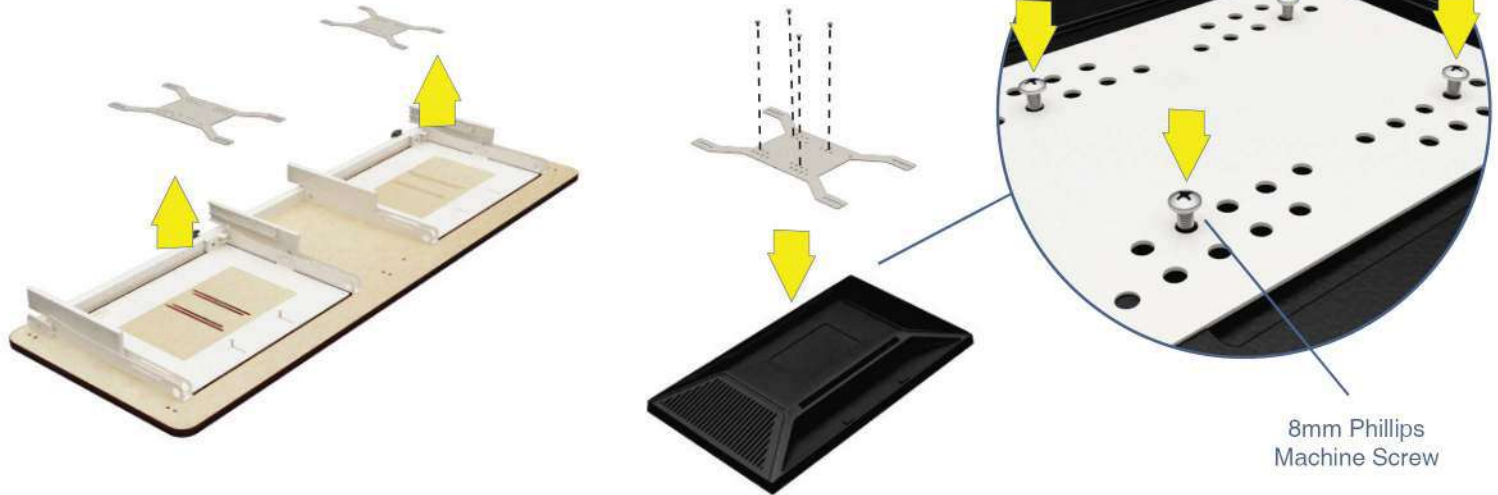

Step 6

LCD Monitor

Attach LCD Monitor to surface using (4) 3/4" Phillips Pan Head Screw on each Monitor.

3/4" Phillips Pan Head Screw



Qty:8

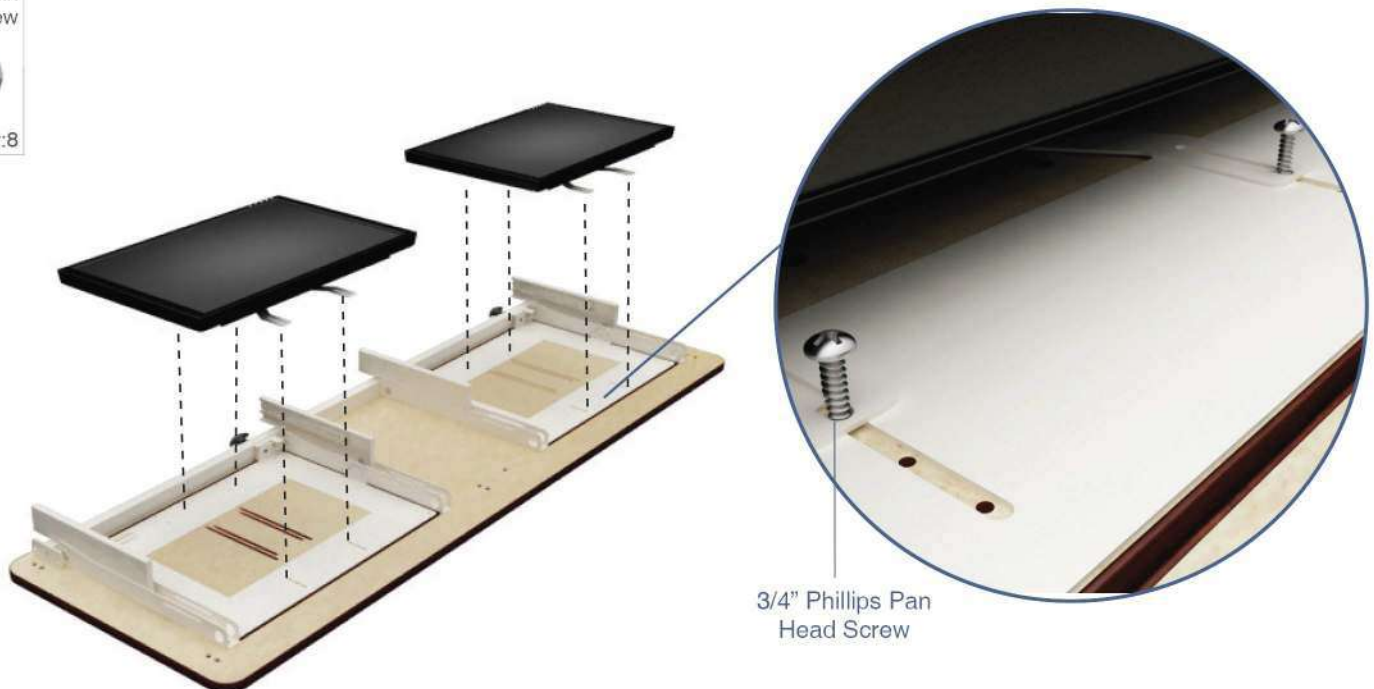

Step 7

Attach Cross Support

Attach Cross Support to Frames using (2) 20mm Furniture Bolts on each side.

20mm Furniture Bolt



Qty:4

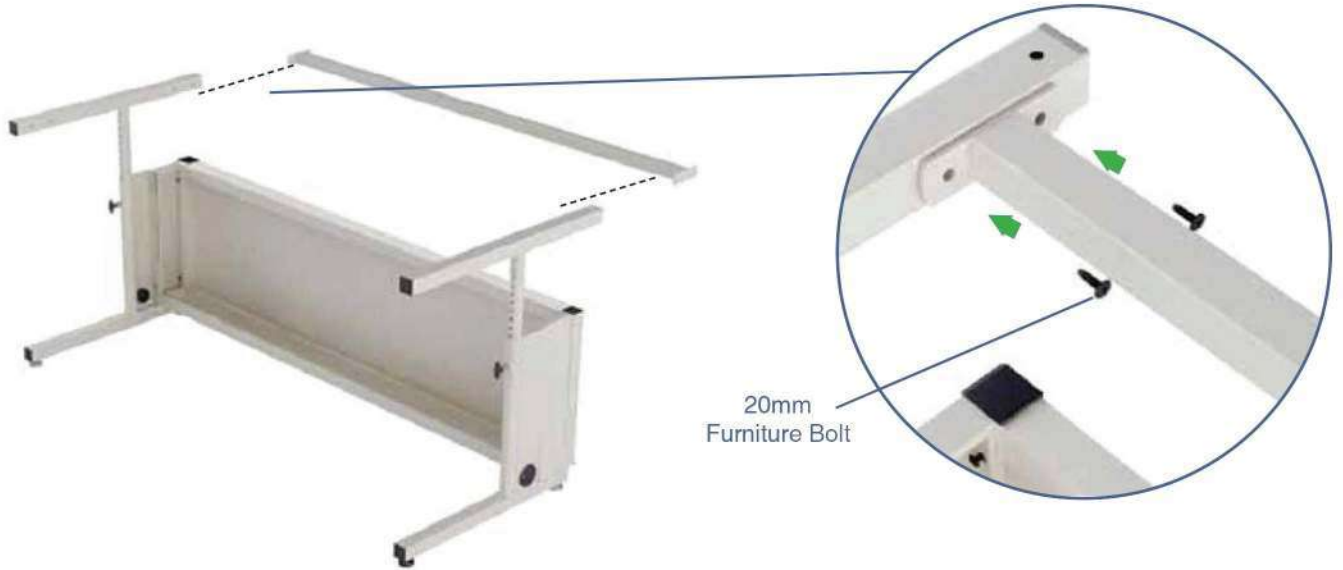

Step 8

Attach Cross Beam and Main Platform

Place Main Surface on top of frame assembly with Cross Support facing forward and attach with (4) 50mm Furniture Bolts. For the Cross Support use (4) 20mm Furniture Bolts.

50mm Furniture Bolts



Qty:4

20mm Furniture Bolt



Qty:4

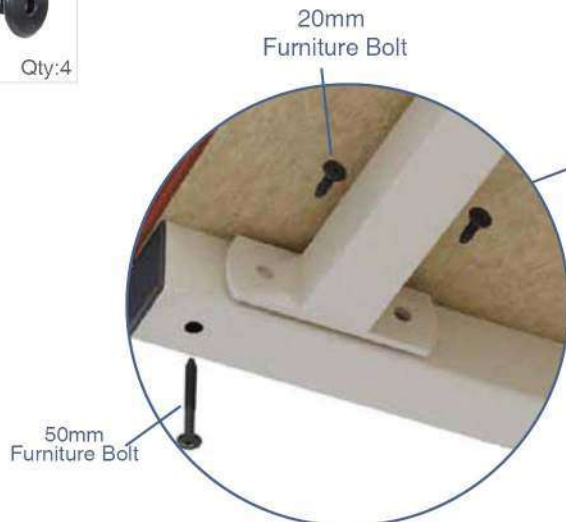

Step 9

Slide in Keyboard Trays

Slide in Keyboard Trays.



Step 10

Wire Management Clips

Insert Wire Management Clips to Channels on surface and run cables through for a cleaner look.

Cable Management Clip



Qty:3 for 36" & 48"
Qty:6 for 60" & 72"



Step 11

Enclosed CPU Holder

Insert CPU Holders into Kick Panel Slots.

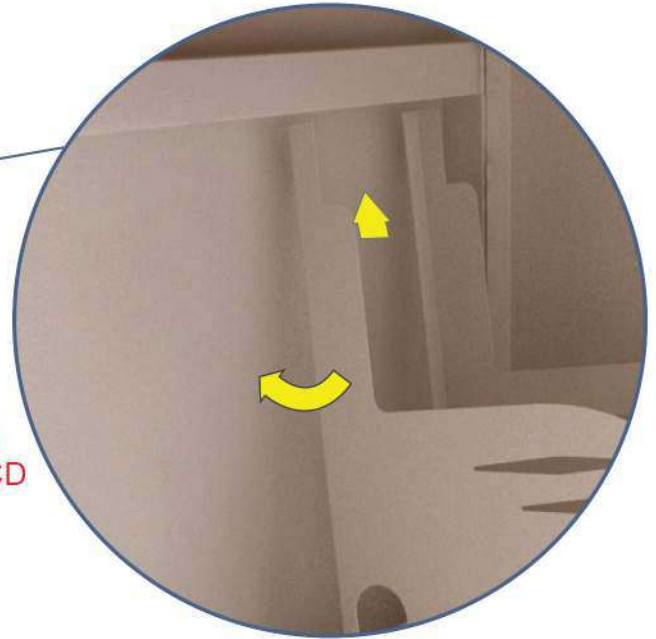
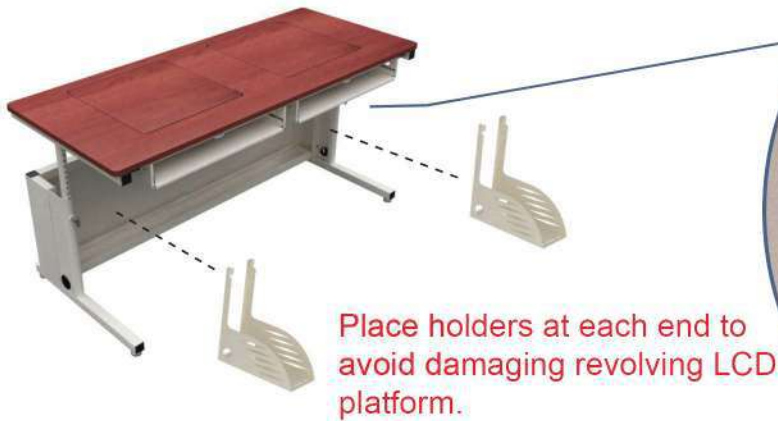

Step 12

CPU Tower Placement

Insert and place CPU Tower in holders. Use Thumb Screws to adjust fitting size of CPU Holder.

